



OPK PERFECT SLIM
SLIDING DOOR SYSTEM EXPERTS

**UNIQUE
WORLDWIDE
PATENTED
SYSTEM**



WELL THOUGHT OUT DOWN TO THE LAST DETAIL FOR A SUPERIOR USER EXPERIENCE



An outstanding user experience combined with real added value for retailers and fabricators have made OPK Europe one of the relevant players in the furniture and building hardware segment in a short space of time - and throughout Europe.

The development of a sliding door marks the beginning of OPK's success story. Step by step, this DNA has given rise to a unique portfolio of the most diverse sliding door solutions, all of which have one thing in common: OPK products are well thought out down to the smallest detail and stand for exceptional quality and maximum comfort.

All products are created in our own development departments. OPK Europe GmbH, based in Germany, develops and distributes country-specific product modifications for the European market.



OPK EUROPE GMBH
Junghansstraße 16
D-72160 Horb am Neckar
Germany
Tel. +49 (0)7451 622 64 0
info@opk-europe.com
www.opkeurope.com

OUR SUCCESS STORY: ADVANCEMENT THROUGH INNOVATION AND COMMITMENT.



1996

The company is established in Chengdu, Sichuan Province.



2000

New production processes require more space. OPK plant is relocated in Xiaolan Town, Zhongshan City.



2006

Development of new product line. OPK becomes an important player in the market for sliding systems.



2007

OPK brand is registered and the logo becomes a trade-mark for sliding door fittings with soft closing devices.



2011

OPK becomes one of the largest manufacturers of sliding doors systems worldwide.



2014

With over 1,200 employees and more than 50,000 sqm of operating space, OPK is one of the leading companies in sliding door systems.



2018

OPK Europe celebrates the opening of the Horb am Neckar location in June 2018.



2019

OPK shows at the Interzum 2019 in Cologne Innovations in opk E-Space and opk Spaceship 80 / 160 construction fittings. OPK présente au salon Interzum 2019 à Cologne.



2023

OPK at Interzum 2023 with the latest trends for sliding door systems.

GAMECHANGER: A MODULAR SYSTEM FOR COMPLETELY NEW ROOM-IN-ROOM CONCEPTS

USING YOUR SMALL FINGER IN-STEAD OF MUSCLE POWER: MOVE UP TO 10 DOORS EASILY AND PARK THEM COMPACTLY.

With Perfect Slim, up to ten sliding doors can be opened simultaneously in both directions or parked on both sides of the passageway to save space. This enables innovative room-in-room concepts in which the glass partition can simply be pushed together as required - without any effort at all. As Perfect Slim no longer requires a fixed floor guide, unevenness in the floor no longer plays a role.

Our technology doesn't really need to hide from anything, but in this case it ensures: no visible screws, no cover panel and a slimline frame design. The rollers can be easily removed from the rail if necessary thanks to their disassembly capability, for example to fill up the integrated oil tank. Thanks to intelligent assembly features, the system can also be installed quickly and easily.

The best is saved for last: Perfect Slim is a flexible modular system that allows you to customise your kit to suit your individual requirements.



NEXT GENERATION SIMPLE, EFFICIENT AND FLEXIBLE.

DURABLE
thanks to reversible running technology. The roller units can be removed if necessary, e.g. to fill the integrated oil tank.

EASY SLIDE
No swinging, no "sinking" thanks to special synthetic rollers that ensure even gliding. Without any effort and without leaving any marks.



INNOVATIVE TWO-WAY DAMPING

With conventional systems two separate damping units are used. This means that the length of the two roller units is increased and therefore a larger minimum door width is required. However, thanks to the innovative two-way damper, doors from a width of 600 mm can be closed smoothly on both sides.



HIDDEN TECHNOLOGY
Thanks to the complete synchronisation technology in the lower profile, the gap size is minimised, which ensures better aesthetics. In addition, no covers are required and no disturbing drill holes are visible.

UP TO 10 DOORS SEAMLESSLY
With Perfect Slim, up to 10 doors can be installed in a row.

DISCREET FRAME DESIGN
As all the technology is housed in the lower section, no cover is required and a discreet frame design is possible.

NO FLOOR GUIDANCE RAILS
Say goodbye to tripping hazards - no visible floor guide rail mounted on the floor.

SAFE IS SAFE
A sliding door lock can also be fitted as an option..

PERFECTION IN DETAIL: SMALL THINGS. BIG EFFECT.

	CONVENTIONAL SYSTEMS	PERFECT SLIM
cover/frame	large cover required, high structure	The complete synchronisation technology is installed in the lower profile, resulting in a small gap. No cover panel required and narrow frames can be realised. No disruptive drill holes or screws visible.
floor guide	fixed floor guide required	Special pressure rollers installed in the lower area, which ensure extreme stability and running quality. No fixed floor guide required. Uneven floors are levelled out and doors are extremely easy to slide.
profile cut	frame profiles must be cut at a 45° angle.	Straight profile cut, as the profiles are covered at the sides. Quick and easy installation - also thanks to our intelligent installation features.
running technology	Running and synchronisation technology are permanently installed together in the upper section.	It is always reversible thanks to the dismountable roller technology. The roller units can be easily removed, e.g. to fill the integrated oil tank.
number of doors	Depending on the number of doors, there is a separate set with a maximum of four doors.	Thanks to the new, innovative connection technology, up to 10 doors can be mounted one after the other which can be parked easily and compactly.

PERFECT SLIM



CONVENTIONAL SYSTEMS



ALLROUNDER: ONE SYSTEM. UNLIMITED POSSIBILITIES.

FROM ONE TO EIGHT: EIGHT DIFFERENT DOOR APPLICATIONS CAN BE REALISED WITH JUST ONE SYSTEM.

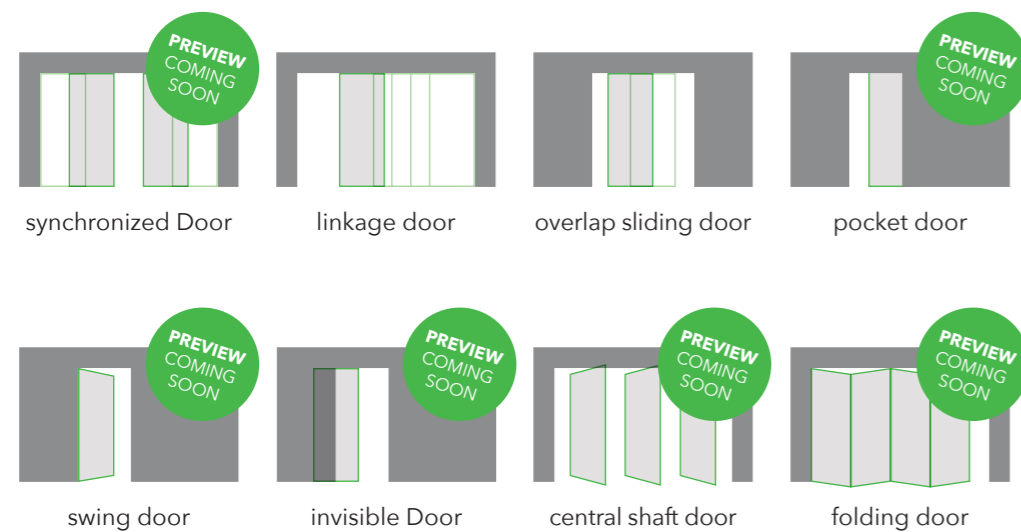

SESAME, OPEN UP: THE DOORS CAN BE OPENED AUTOMATICALLY OR MANUALLY.

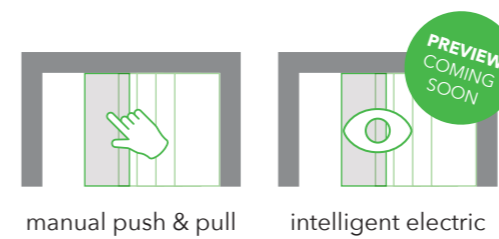

PERFECTLY FITTING DOOR HANDLES

Our diverse range of premium quality door handles not only give your doors an aesthetically pleasing appearance, but also ensure a secure and comfortable grip when operating the door.



NO LIMITS: YOU HAVE THE IDEA. WE HAVE THE RIGHT SOLUTION. WANT TO BET?

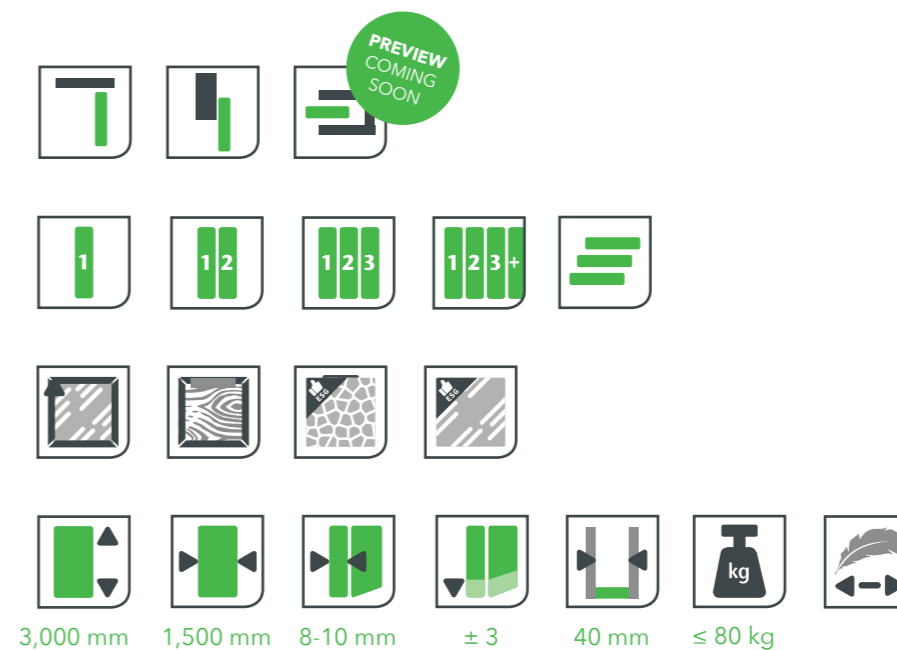

BUILD TO ORDER AS SIMPLE AS IT IS GENIUS: ONE KIT. EVERYTHING IN IT.

SUSTAINABLE AND COST-SAVING: OUR INNOVATIVE MODULAR SYSTEM.

Perfect Slim is available as a single sliding door that runs in front of the wall or under the ceiling. If you prefer multi-leaf sliding doors, you can realise these by combining two individual sliding doors. For glass partition walls with three or more doors, you will receive a practical kit for each door that contains everything you need for installation.

Each kit contains the following components: Fittings, rail system and aluminium frame. Depending on the type of installation (ceiling or wall) and the number of doors, you can customise the kit and only order the elements you need. This process is uncomplicated and also saves costs, as no unnecessary components are included.

Below we present a selection of examples to illustrate this.



**ORDER EXAMPLE:
ONE DOOR**
CEILING/WALL MOUNTING
ALUMINIUM FRAME

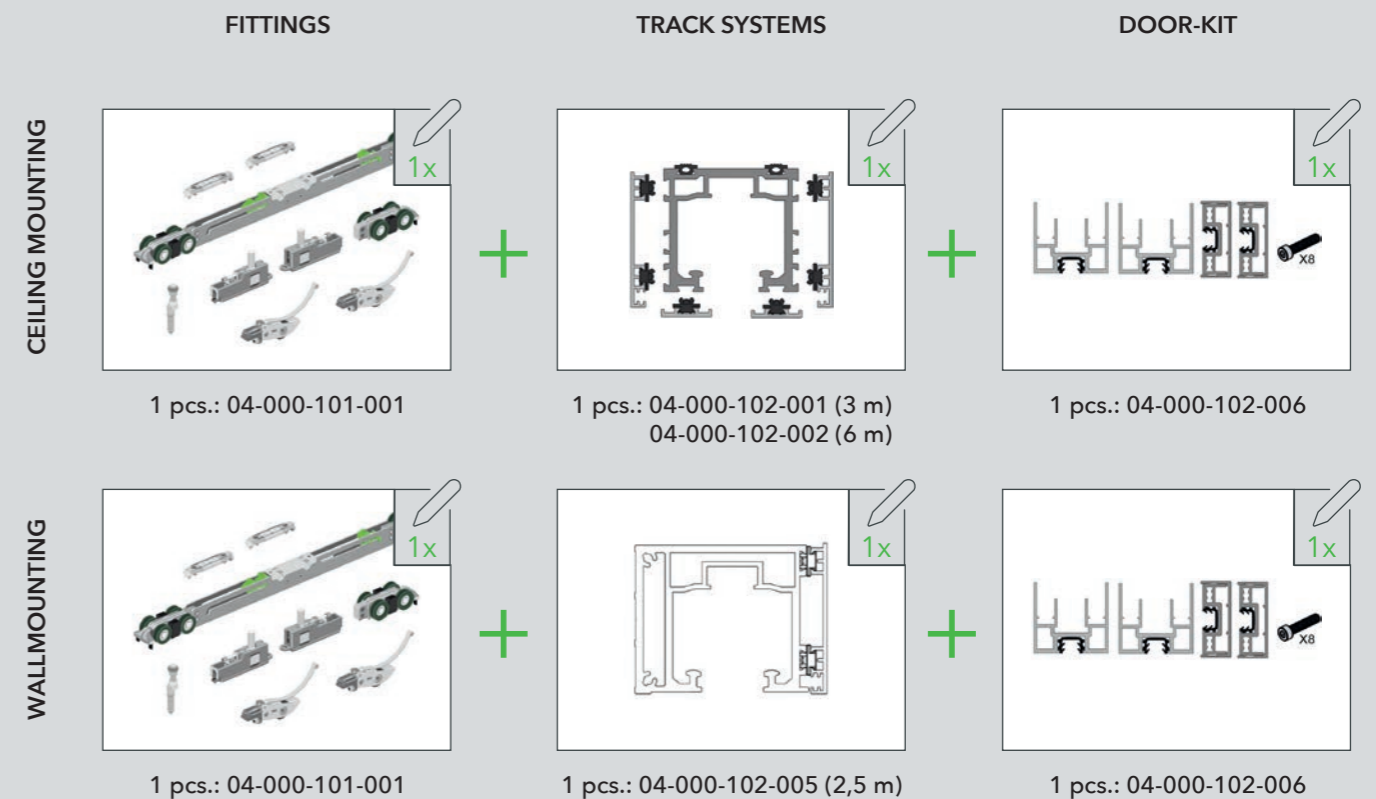



**ORDER EXAMPLE:
TWO DOORS**
CEILING MOUNTING
ALUMINIUM FRAME



**ORDER EXAMPLE:
THREE DOORS**
CEILING MOUNTING
ALUMINIUM FRAME

FITTINGS

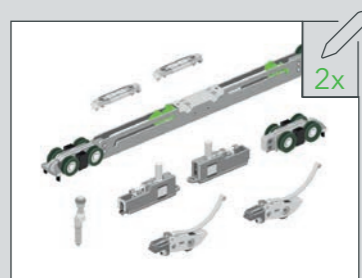

1 pcs.: 1x 04-000-101-001
1x 04-000-101-002

TRACK SYSTEMS

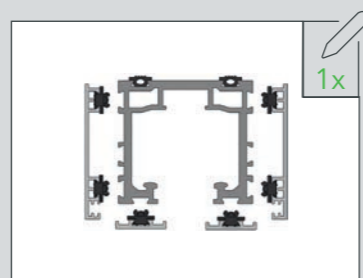

1 pcs.: 04-000-102-001 (3 m)
04-000-102-002 (6 m)

DOOR-KIT



2 pcs.: 04-000-102-006

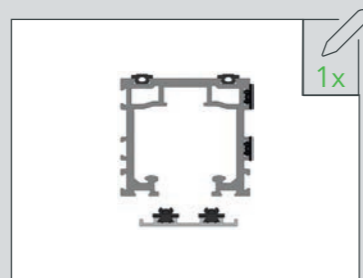

1 pcs.: 04-000-102-003 (3 m)
04-000-102-004 (6 m)

FITTINGS



2 pcs.: 04-000-101-001

TRACK SYSTEMS

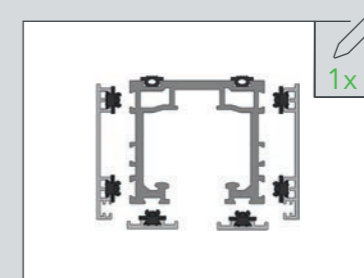

1 pcs.: 04-000-102-001 (3 m)
04-000-102-002 (6 m)

DOOR-KIT



2 pcs.: 04-000-102-007

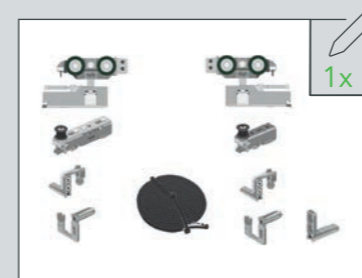

1 pcs.: 04-000-101-002

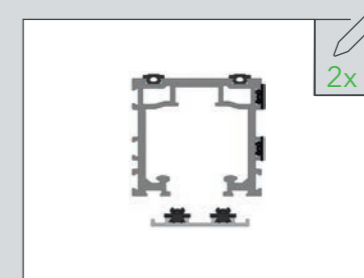

2 pcs.: 04-000-102-003 (3 m)
04-000-102-004 (6 m)

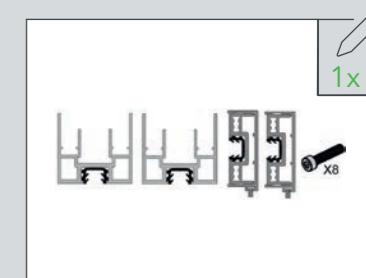

1 pcs.: 04-000-102-008



**ORDER EXAMPLE:
FOUR DOORS**
CEILING MOUNTING
ALUMINIUM FRAME



**ORDER EXAMPLE:
FIVE DOORS**
CEILING MOUNTING
ALUMINIUM FRAME

FITTINGS

TRACK SYSTEMS

DOOR-KIT

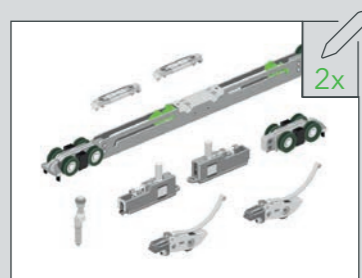

2 pcs.: 04-000-101-001

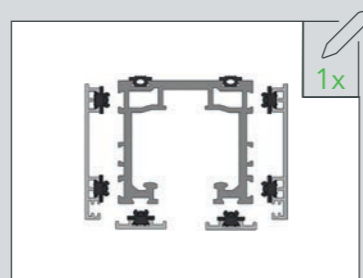

1 pcs.: 04-000-102-001 (3 m)
04-000-102-002 (6 m)



2 pcs.: 04-000-102-007



2 pcs.: 04-000-101-003



3 pcs.: 04-000-102-003 (3 m)
04-000-102-004 (6 m)



2 pcs.: 04-000-102-008

FITTINGS

TRACK SYSTEMS

DOOR-KIT



2 pcs.: 04-000-101-001

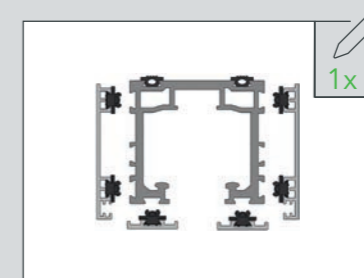

1 pcs.: 04-000-102-001 (3 m)
04-000-102-002 (6 m)

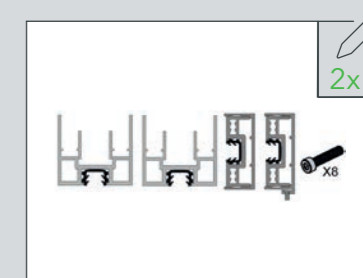

2 pcs.: 04-000-102-007

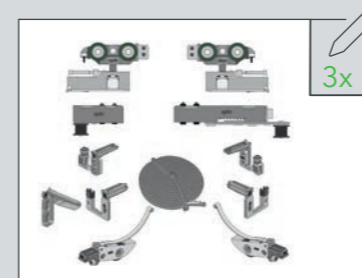

3 pcs.: 04-000-101-003

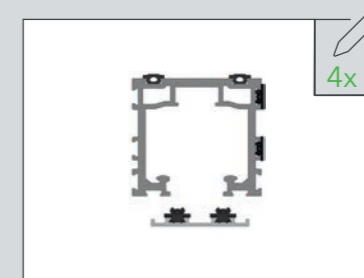

4 pcs.: 04-000-102-003 (3 m)
04-000-102-004 (6 m)

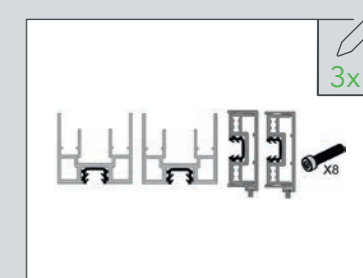

3 pcs.: 04-000-102-008

UNIQUE WORLDWIDE PATENTED TECH- NOLOGY

OPK has always ensured a unique production of sliding door systems through its ability to search for innovative solutions.

In addition to continuously developing the best technical solutions for customers, OPK also manufactures numerous globally patented products that characterise the market due to their unique properties.

One example of this is the latest Perfect Slim sliding door system, which is considered to be pioneering thanks to its patented running technology and door movement method. The demountable roller unit, the embedded assembly technology and special stabilising guide rollers are just a few examples of the patented technology that makes Perfect Slim so unique.



ASSEMBLY KIT COMPLICATED? THAT WAS YESTERDAY.



- 01. Pattern for determining the length of the belt.
- 02. Pliers to connect the toothed belt to the fittings.
- 03. Extended bit to connect the aluminium frames.
- 04. Drilling pattern to set the drilling points in the profile.
- 05. Drill to make the holes in the profiles.

The intelligent installation features make installation very easy. For the single door, these include the guide pin with eccentric guide, which is characterised by a particularly narrow design. The drilling patterns, which are inserted into the rail to prevent errors during installation. And another pattern for correctly measuring the timing belt - to name just a few.

To ensure that our customers can enjoy their sliding doors for a long time, we recommend fitting our specially developed edge protector, which is supplied with every kit, to the frame. This ensures that all four corners are perfectly protected.

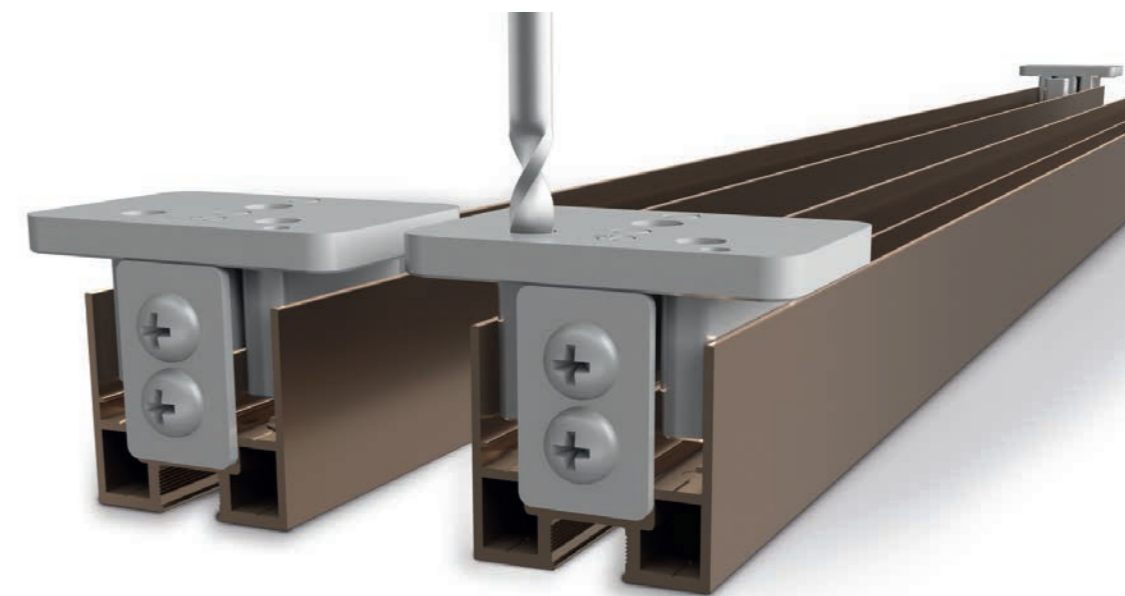



OPK EUROPE GMBH
Junghansstraße 16
D-72160 Horb am Neckar
Germany
Tel. +49 (0)7451 622 64 0
info@opk-europe.com
www.opkeurope.com



opk[®]